

1909

HEIGSTLER

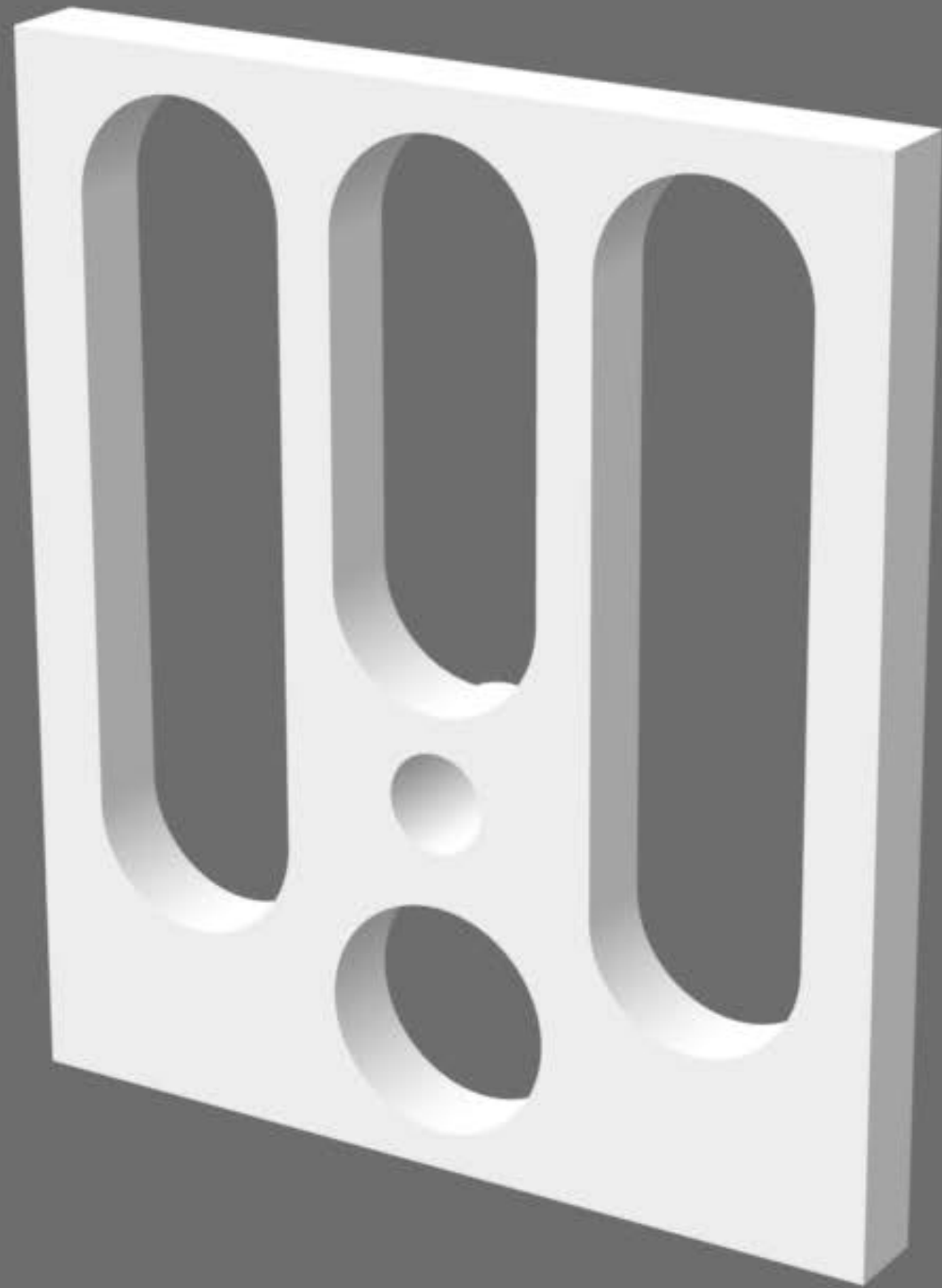

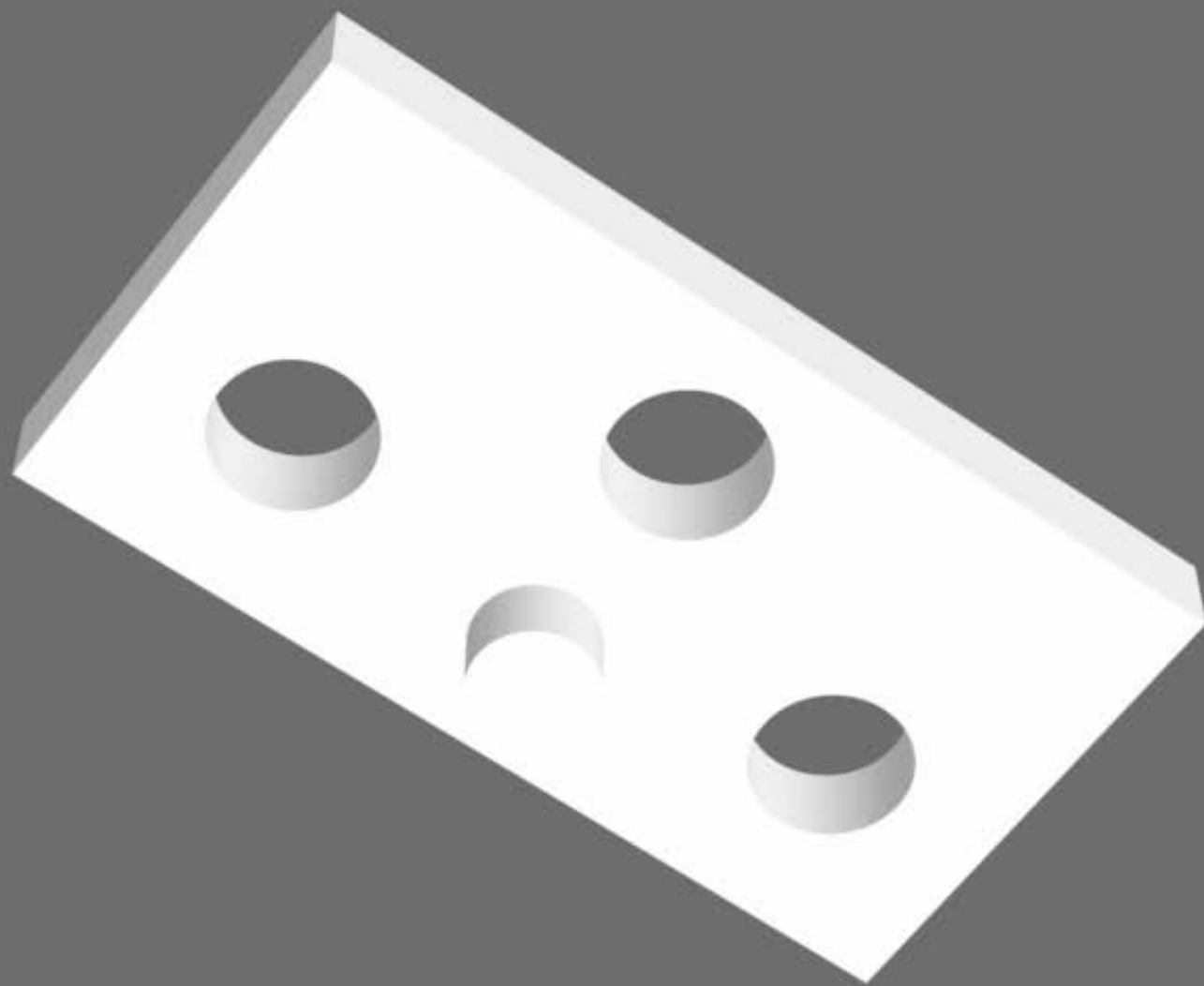



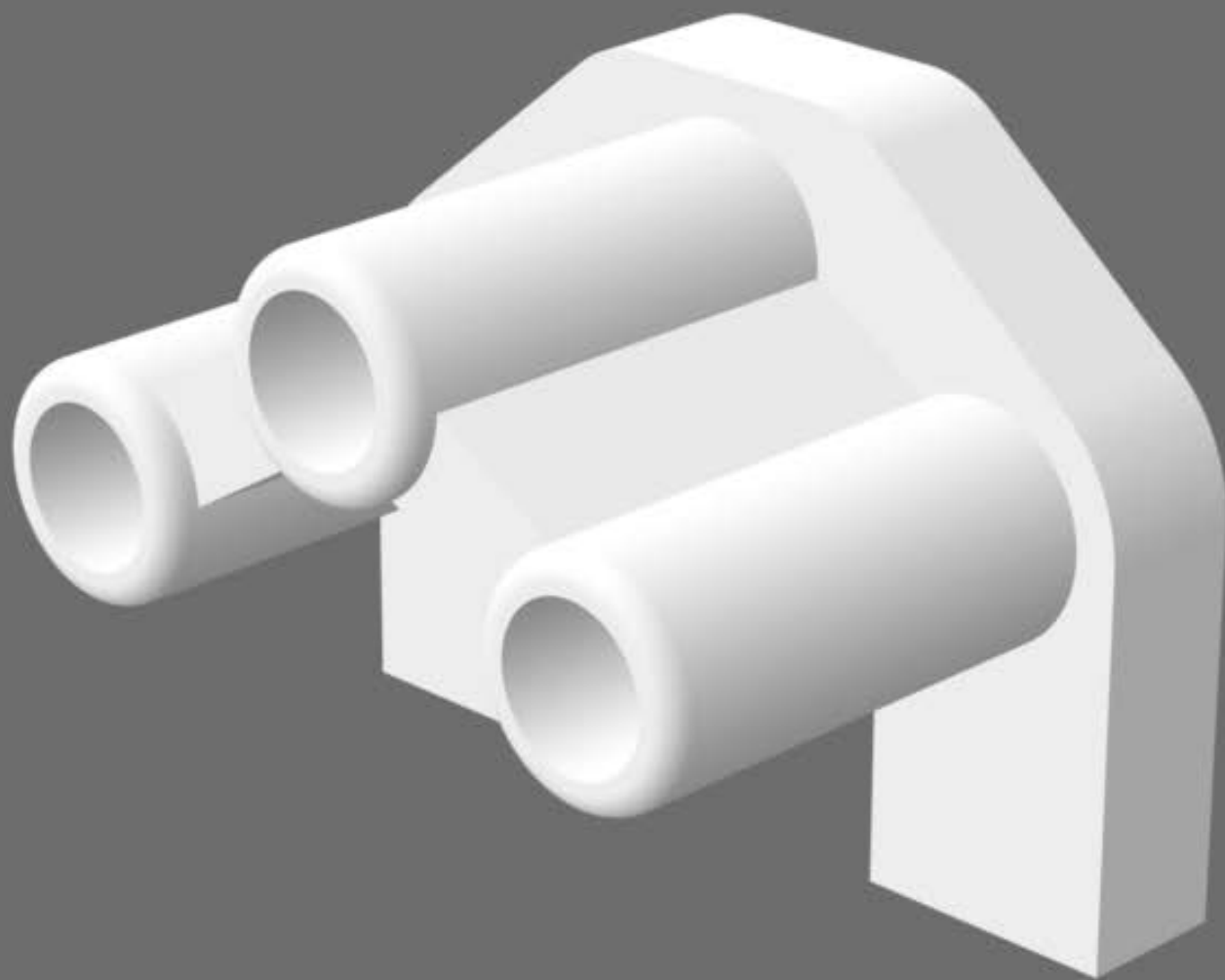

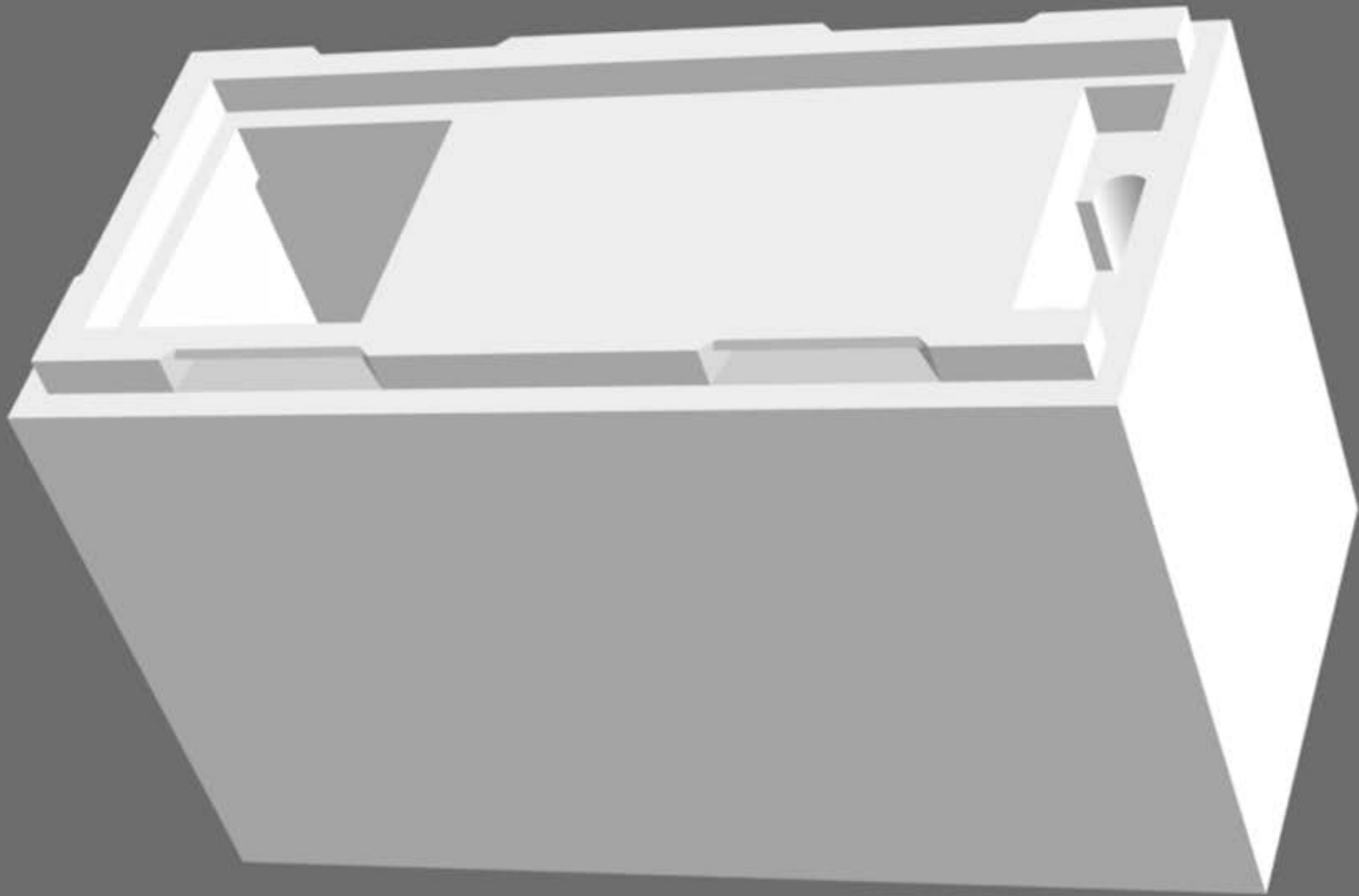

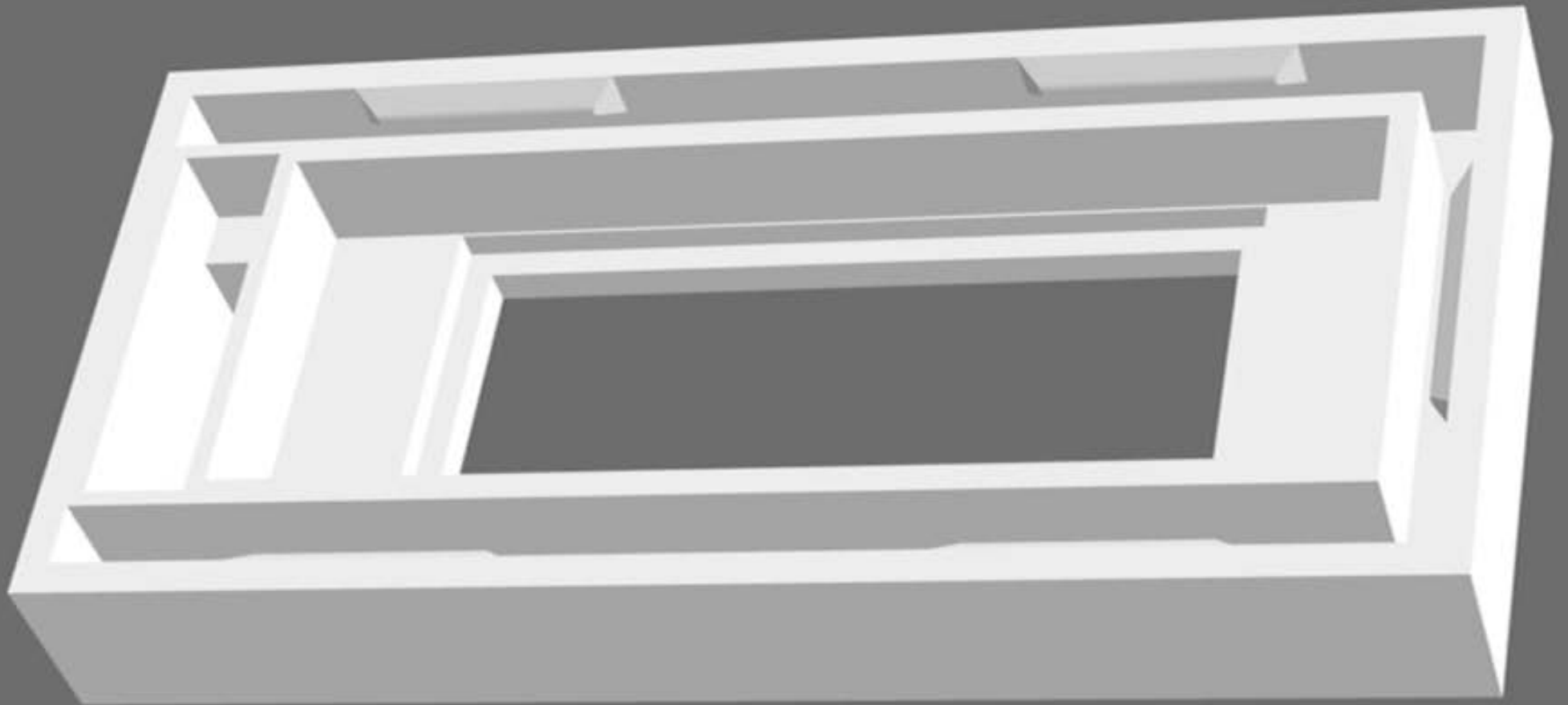

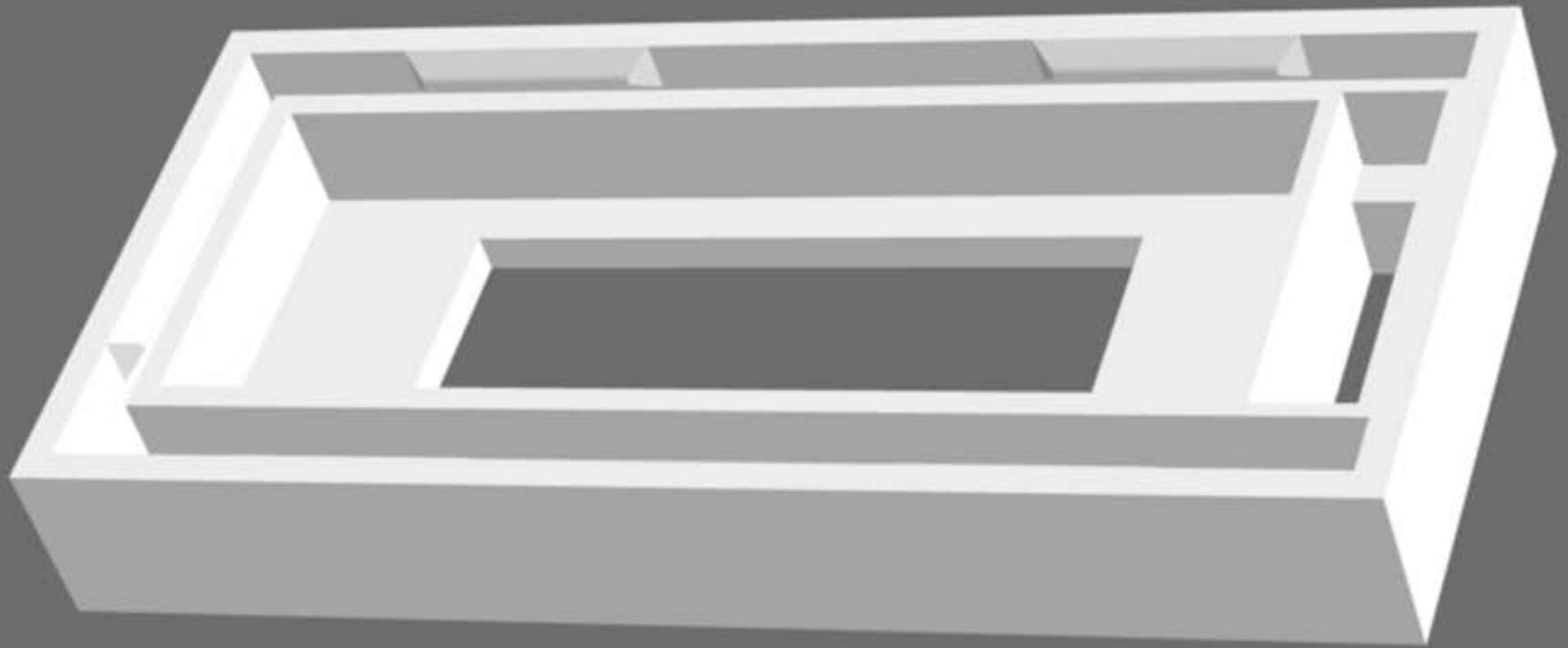

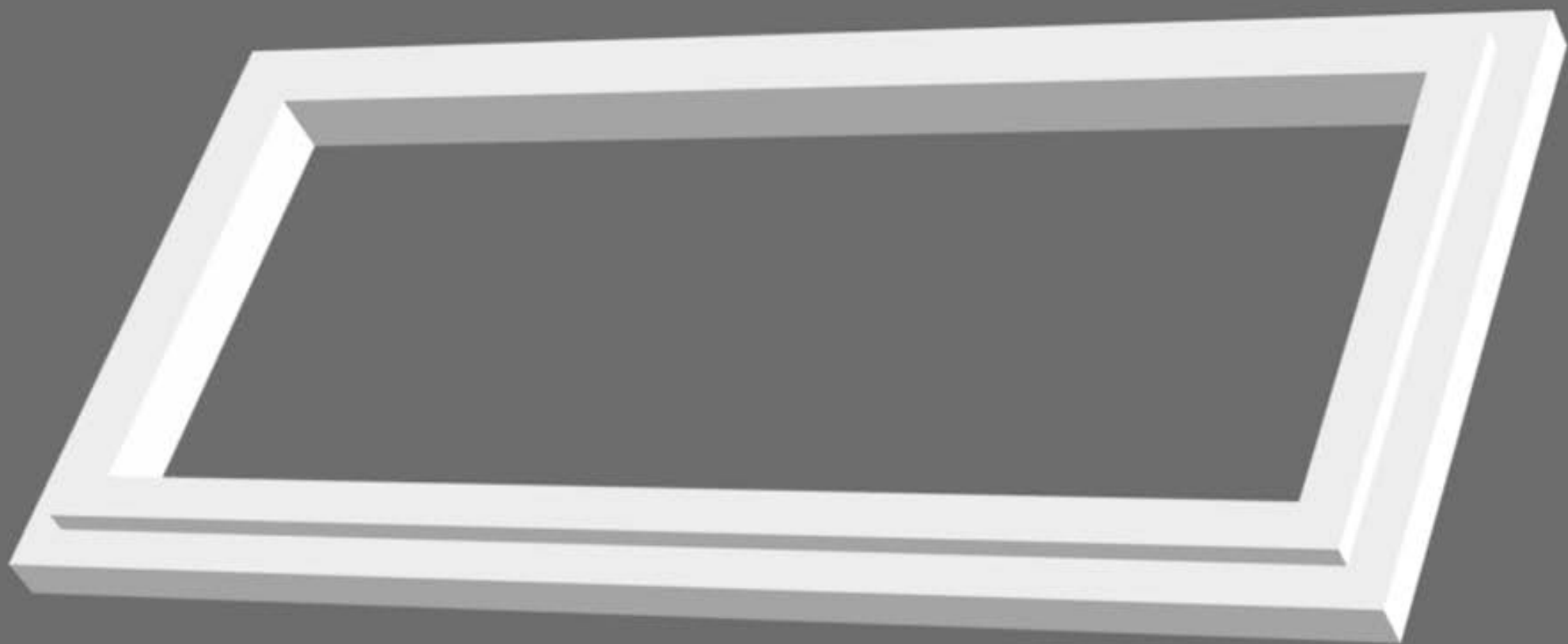



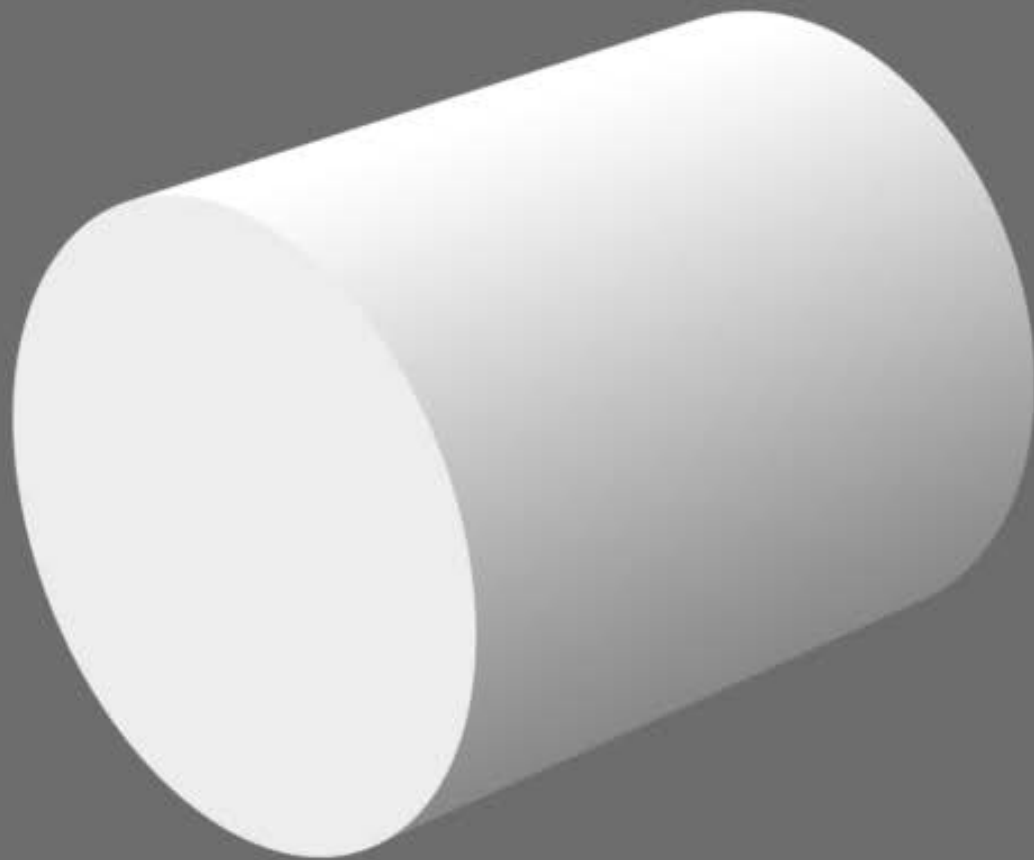

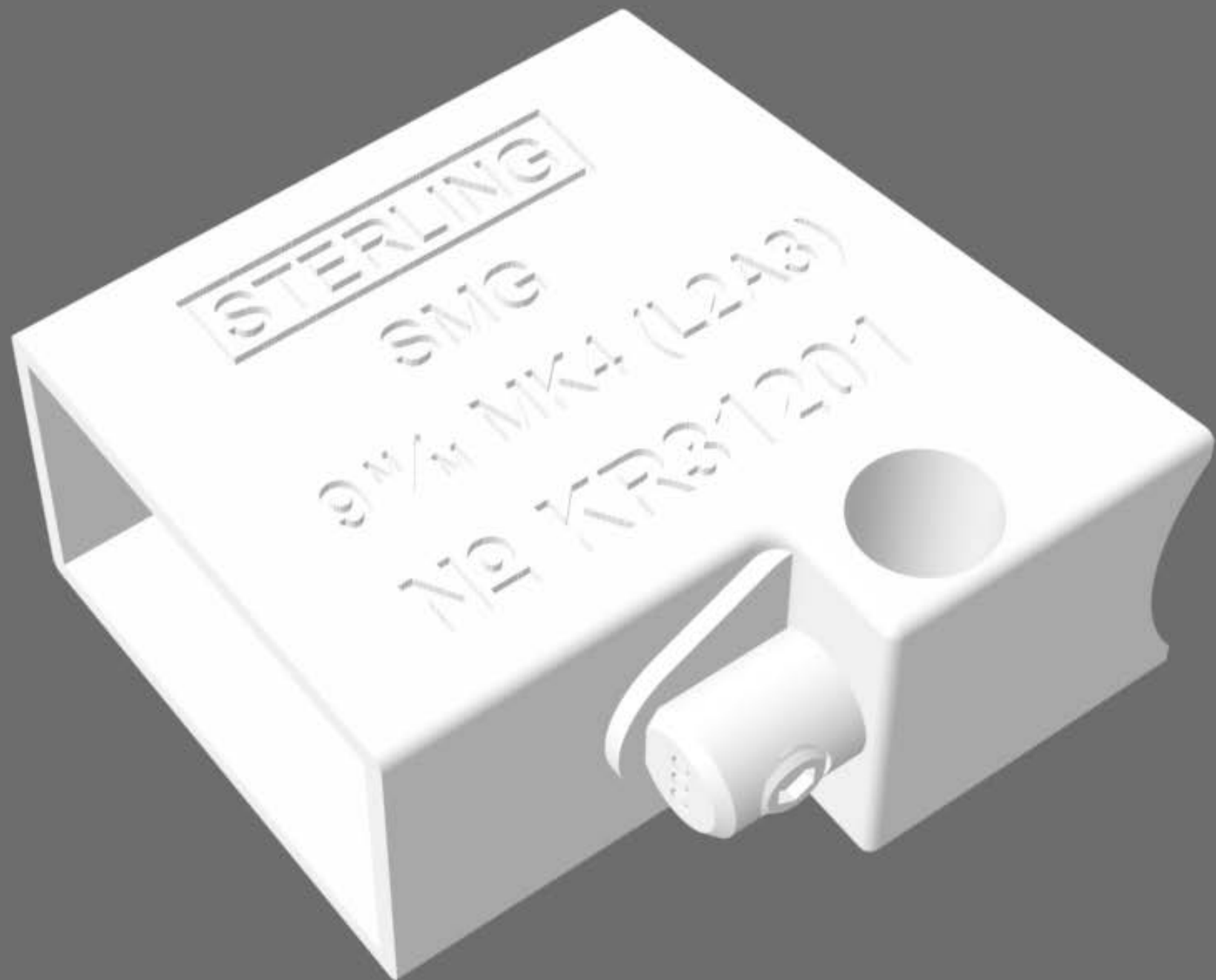

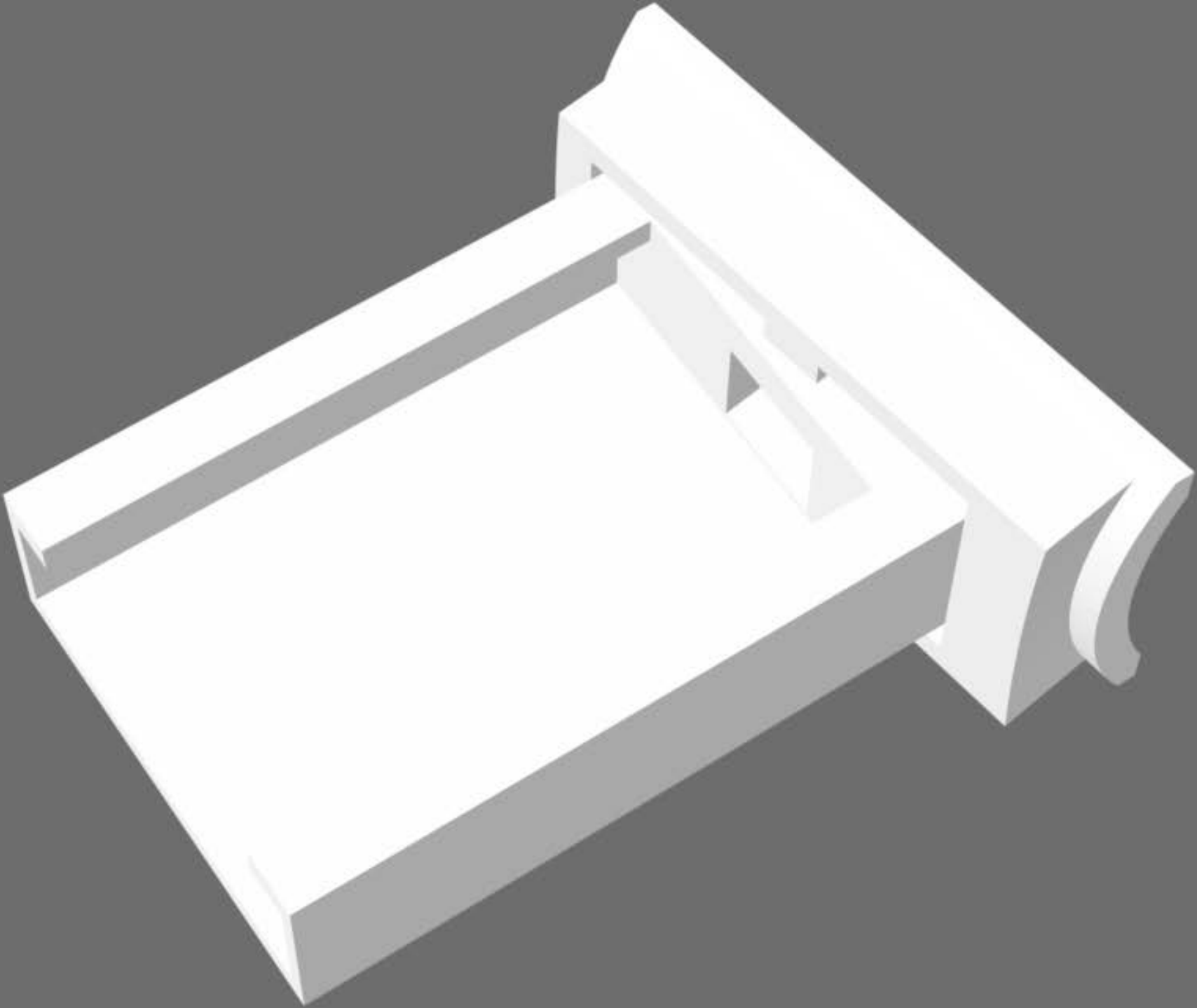

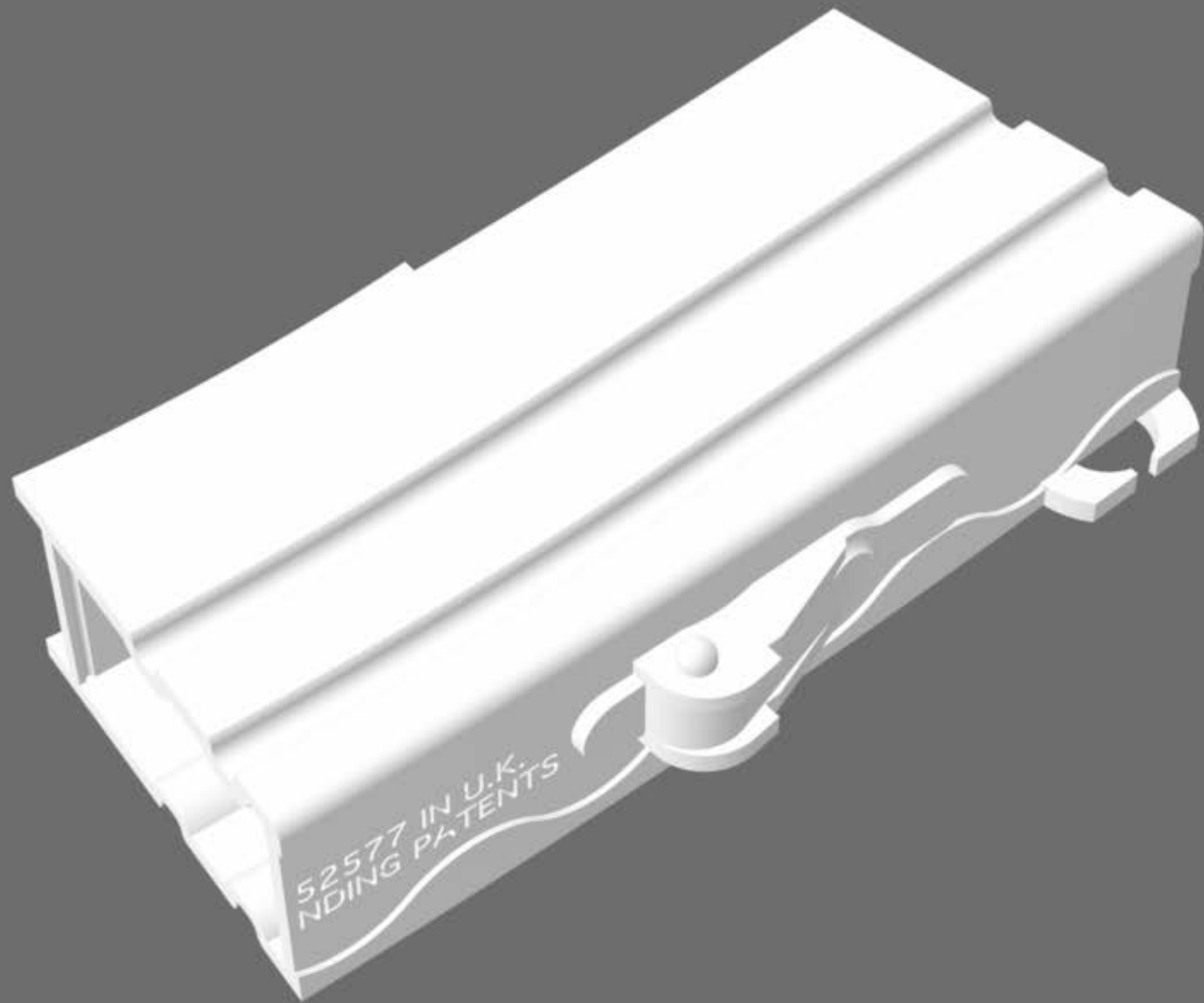

52577 IN U.K.  
PENDING PATENTS

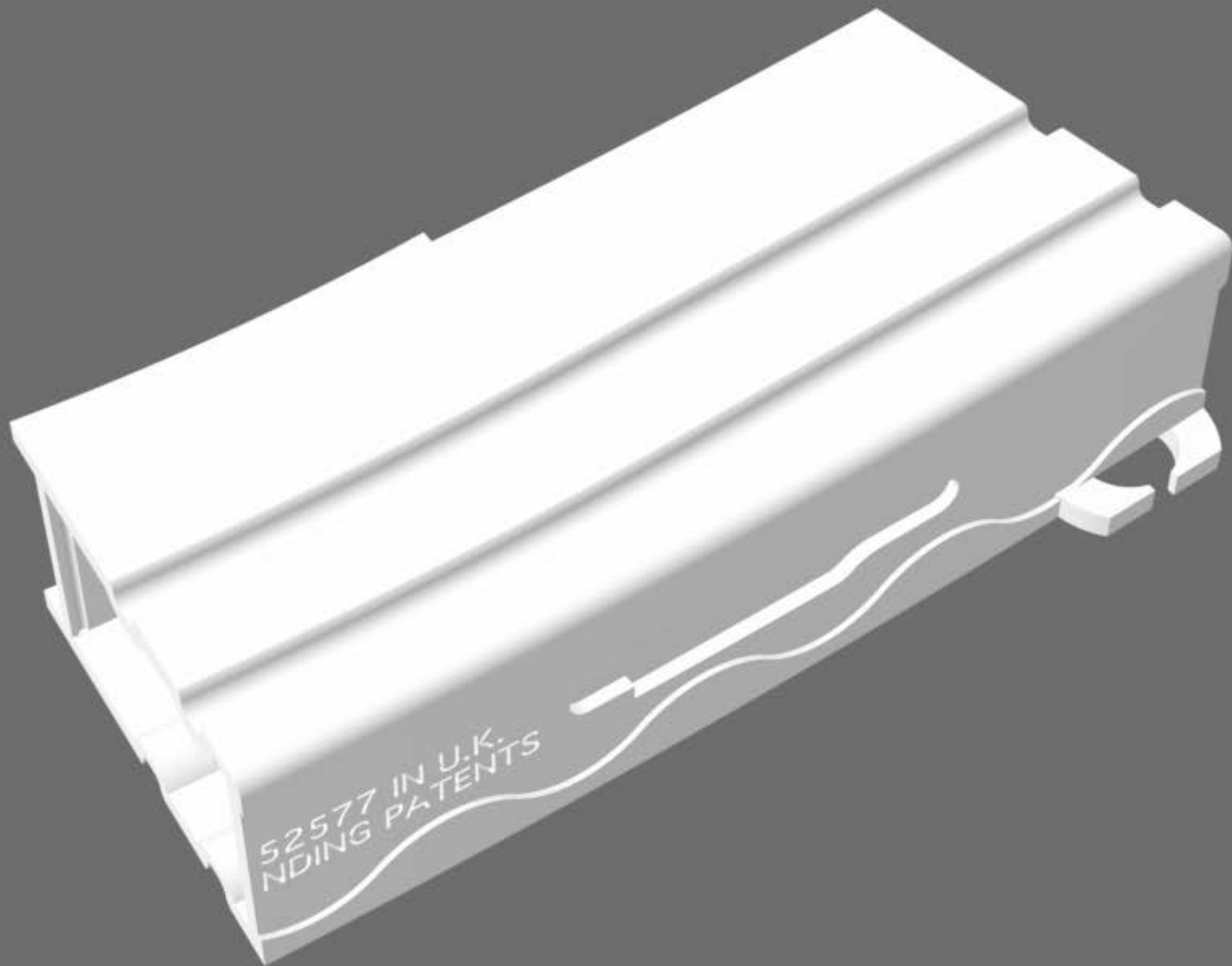

52577 IN U.K.  
PENDING PATENTS

