



PropTroniX

NN-14 Blaster

Build Instructions

Table of Contents

1. [About the NN-14 Blaster](#)
2. [Tools List](#)
 - 2.1. [3D Model](#)
 - 2.2. [Electronics](#)
3. [Sanding & Filling](#)
4. [Priming & Painting](#)
5. [List of Parts](#)
 - 5.1. [Barrel](#)
 - 5.2. [Main Body](#)
 - 5.3. [Trigger & Grip](#)
 - 5.4. [Chassis](#)
 - 5.5. [Stand](#)
6. [Hardware Component's](#)
7. [Assembly Guide](#)
 - 7.1. [Barrel](#)
 - 7.2. [Main Body](#)
 - 7.3. [Trigger and Grip](#)
 - 7.4. [Chassis](#)
 - 7.5. [Stand](#)
8. [Completed Images](#)
9. [YouTube Video - BLTroniX NN-14 Blaster Demo](#)
10. [Links to the Additional Kits](#)

1. *About the NN-14 Blaster*

Introduced in Star Wars Episode VII “The Force Awakens” in 2015, the NN-14 Blaster Pistol was manufactured by LPA.

The blaster featured a compact grip, enlarged power core, reinforced frame, a safety switch, armoured body shell, and flash suppressing/stabilising muzzle.

Han Solo owned one and later gave it to the scavenger Rey, who went on to use the blaster against the First Order. When she went to find Luke Skywalker, she was seen with a holster for her NN-14.

Han Solo: You might need this. [Passes a Blaster to Rey]

Rey: I think I can handle myself.

Han Solo: I know you do. That's why I'm giving it to you. Take it. You know how to use one of those?

Rey: Yeah. You pull the trigger.

Han Solo: Little bit more to it than that. You got a lot to learn.

My version of the NN-14 Blaster has been designed with the capability of adding Electronics for Light and Sound. It has also been designed for ease of printing and also painting the individual parts to get the best possible finish. All the images used in these Build Instructions are images from my design done in Fusion360. I do not consider it to be 100% screen accurate but it's pretty close.

STAR WARS THE FORCE AWAKENS



2. Tools List

The following tools are what I recommended to use to build your NN-14 Blaster.

2.1. 3D Model

- Eye Protection - Goggles to protect your eye's from the dust particles
- Dust Mask - For protection from breathing in the dust particles
- Sandpaper - Various grades 80 Grit, 180 Grit and Wet & Dry 600 Grit (A few sheets of each)
- Small Metal Files - Various widths and shapes
- Super Glue
- 2 Part Epoxy Glue
- Small Pair of Side Cutters
- Needle Nose Pliers
- Exacto Knife
- Filler - Bondo, wood filler, fine car filler or any other type of filler that is easy to sand can be used.
- Paint - Filler Primer, Colours of your choice

2.2. Electronics

- Multi-Meter - For testing circuits and connections (**VERY IMPORTANT**)
- Soldering Iron or Soldering Station
- Solder
- Solder Wick
- Wire - 28AWG or 30AWG Silicon wire recommended
- Wire Stripper
- Heat Shrink Tubing - Various Sizes
- Hot Air Gun, Lighter or Solder Station - For shrinking heat shrink tubing
- Small Pair of Side Cutters
- Needle Nose Pliers
- Solder Helper - Optional

3. Sanding and Filling

Sanding all the parts is a necessary process and the more time you take on this process the better the finish of your NN-14 Blaster will be. Start with the 80 grit sandpaper and reduce the grit until a nice smooth finish is achieved.

PLEASE WEAR A DUST MASK & GOGGLES WHEN SANDING

DO NOT USE POWER TOOLS for sanding, these create heat very quickly and will soften the plastic and potentially ruin the part. Hand sanding is a much slower process but with patience and time you will achieve a really good finish ready for assembling and painting.

- Rounded Parts - Roll sandpaper around the part to sand, both inside and outside of barrels can be sanded this way.
- Flat Surfaces - Use a sheet of sandpaper on a flat surface to sand these parts.
- Awkward Shapes and Small Details - Use small metal files with shaped sides and sanding sticks to sand these parts, being careful not to sand away the details too much.

Check all parts for voids and gaps and fill with filler, once dry and hardened sand these parts again. Only move on to assembling the NN-14 Blaster once you are really happy with the sanded finish of all the parts.

4. Priming and Painting

The main colours used for painting the NN-14 Blaster are Silver and Black, but you can paint it in whatever colours you choose. I recommend using cans of acrylic spray paints, but you can also use an airbrush.

PLEASE WEAR A MASK WHEN PAINTING

- Always paint in a well ventilated area, preferably outside.
 - Wear PPE (Personal Protective Equipment) when painting.
 - Hang parts for printing where possible - This gives a better angle for painting and also for drying the parts.
 - Apply several light coats of paint rather than one which coats and try to avoid drips and runs.
1. Filler Primer - Spray Paint all parts with Filler Primer - This will fill any very small voids or gaps. If there are still some voids and gaps fill these with filler and sand all the parts with very fine grit wet and dry sandpaper to achieve a real good smooth finish ready for the final colour.
 2. Main Colour - Use several light coats of paint allowing each to dry for the recommended time before applying the next coat. Don't rush and try to paint thick coats of paint, you will possibly lose some of the finer details on the parts, and possibly have to start the sanding process again.
 3. Allow the paint to fully dry before attempting to assemble the NN-14 Blaster. I recommend at least 24 hours.
 4. Remember any parts that are required to be glued together will need to have the paint sanded first. Gluing Painted parts together is NOT recommended.
 5. Weathering - This is a personal choice. If you want to give your NN-14 Blaster the weathered look check out the many videos on YouTube showing how to achieve that weather look.

5. List of Parts

5.1. Barrel

Name	Paint Colour	Supports Yes/No
Main Barrel	Black	NO
Barrel End Cap	Black	YES
Small Barrel	White	NO
Barrel LED Holder	Black	NO

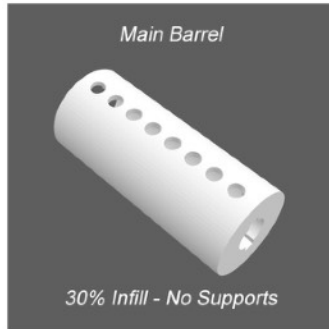

5.2. Main Body

Name	Paint Colour	Supports Yes/No
Main Body (BOTTOM)	Silver or Aluminium	YES
Main Body (TOP)	Silver or Aluminium	YES
Main Body Panel (LEFT)	Silver or Aluminium	NO
Main Body Panel (LEFT) - OLED	Silver or Aluminium	YES and RAFT
Main Body Panel (RIGHT)	Silver or Aluminium	NO
Main Body Front Plate (BOTTOM)	Silver or Aluminium	NO
Main Body Front Plate (TOP)	Silver or Aluminium	NO

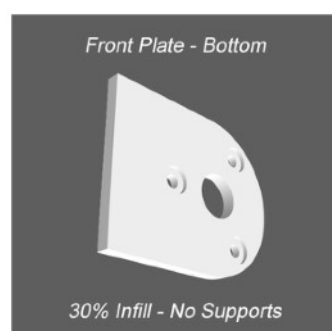
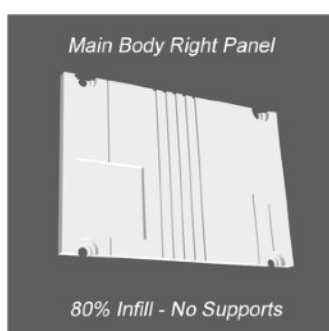
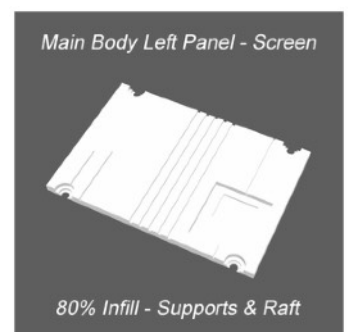
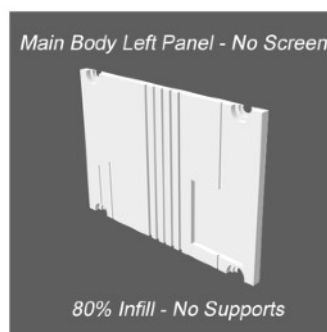
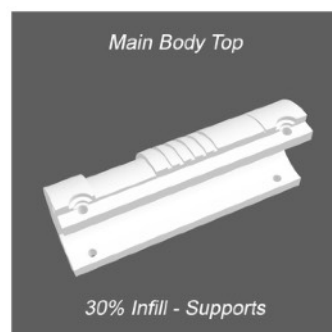

Notes

If using the OLED Display the LEFT Panel will need to be printed upright so will need to have a raft as well as supports.

5.3. Trigger and Grip

Name	Paint Colour	Supports Yes/No
Grip Frame	Silver or Aluminium	NO
Main Body Back Plate	Silver or Aluminium	NO
Grip Plate (LEFT)	Silver or Aluminium	NO
Grip Plate (RIGHT)	Silver or Aluminium	NO
Slider Mechanism	Silver or Aluminium	NO
Slider Base Plate	Silver or Aluminium	NO
Slider Button	Silver or Aluminium	YES
Trigger	Black	NO
Grip Handle (RIGHT)	Black	NO
Grip Handle (LEFT)	Black	NO

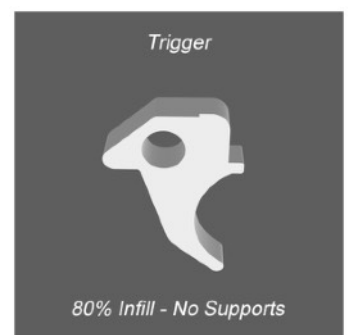
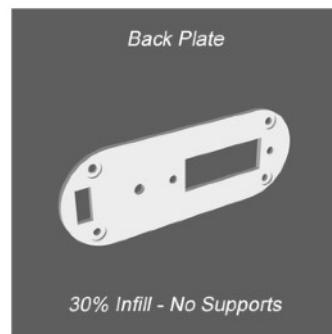
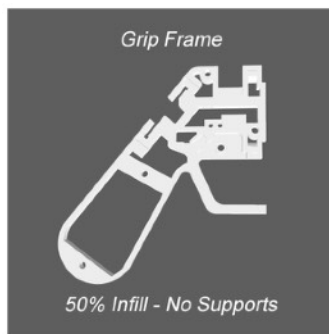

5.4. Chassis

Name	Paint Colour	Supports Yes/No
Chassis Main Body	Any	YES
Chassis Cover	Any	YES
Chassis One Piece	Any	YES

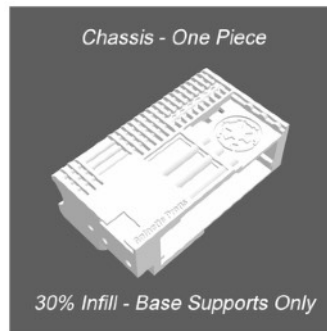
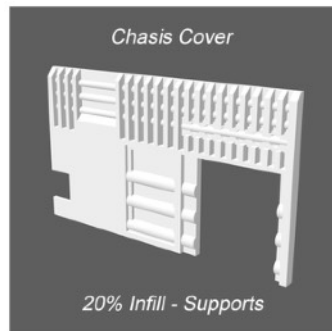
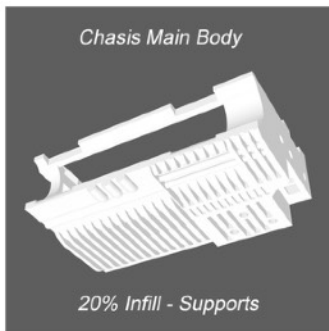

Notes

The Chassis can be printed as one piece but this makes it harder to install the electronics.

5.5. Stand

Name	Paint Colour	Supports Yes/No
Stand Base	Black	NO
Long Stand Upright	Black	NO
Short Stand Upright	Black	NO



Notes





The Stand can be painted any colour you like..

6. Hardware Components



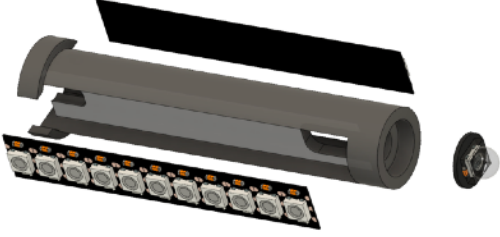

Name & Type	Length	Quantity	Location
M3 Button Head	6mm	3	Front Plate TOP
M3 Button Head	6mm	3	Front Plate BOTTOM
M3 Button Head	6mm	4	Panel LEFT
M3 Button Head	6mm	4	Panel RIGHT
M3 Button Head	6mm	4	Back Plate
M3 Button Head	6mm	2	Back Plate to Grip Frame
M3 Button Head	6mm	4	Grip Plate to Grip Frame
M2 Button Head	6mm	4	Grip Plate to Grip Frame
M3 Button Head	6mm	4	Grip Handle
M2 Button Head	4mm	2	Slider Base Plate
M3 Grub Screw	4mm	2	Barrel End Cap to Barrel
Neodymium Magnets	6mm x 3mm	2	Front Plate BOTTOM to Body Bottom
Neodymium Magnets	3mm x 2mm	4	Front Plate BOTTOM to Body Bottom

7. Assembly Guide

7.1. Barrel

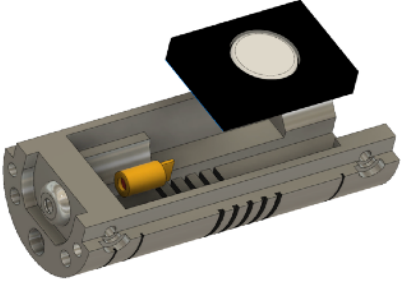
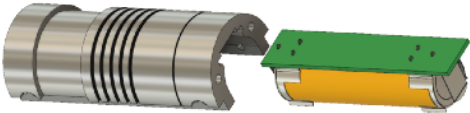
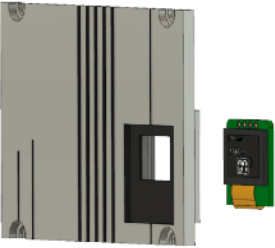
	<p>Fix the two WS2812B LED Neopixel strips, one to each side of the “Barrel LED Holder” and insert the single WS2812B Neopixel to the front of the “Barrel LED Holder”</p> <p>Electronics: Two strips of 10 WS2812B Neopixel LED's Single WS2812B Neopixel LED Neopixel LED Lens</p>
	<p>Slide the “Barrel LED Holder” “inside the “Main Barrel”</p>
	<p>Place the “Barrel End Cap” on to end of the “Main Barrel”</p>
	<p>Secure the “Barrel End Cap” in place with 2 x M3 x 4mm Grub Screws</p> <p>Hardware: 2 x M3 x 4mm Grub Screws</p>
	<p>1st Stage Complete</p>

7.2. Main Body

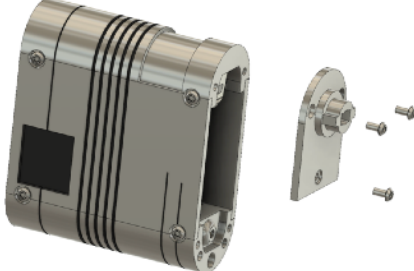
	<p>Use Hot Glue if needed to secure the Speaker and Red Dot Laser into the “Main Body Bottom”</p>
	<p>Electronics: Speaker 5V Red Dot Laser Diode</p>
	<p>Slide the PropTroniX 18650 Battery Holder into the grooves in “Main Body Top”</p> <p>Electronics: PropTroniX 18650 Battery Holder</p>
	<p>Slide the 0.66” OLED Display into the groove in the back of the “Main Body Panel LEFT”</p> <p>Electronics: 0.66” OLED Display</p>
	<p>Align “Main Body Panel LEFT” and “Main Body Panel RIGHT” into the grooves on “Main Body Bottom “and “Main Body Top”</p>
	<p>Make sure you align the screw holes</p>
	<p>Use 8 x M3 x 6mm Button Head Screws to secure the parts together</p> <p>Hardware: 8 x M3 x 6mm Button Head Screws</p> <p>Align “Front Plate Top” to the “Main Body” and use 3 x M3 x 6mm Button Head Screws to secure in place</p> <p>Hardware: 3 x M3 x 6mm Button Head Screws</p>

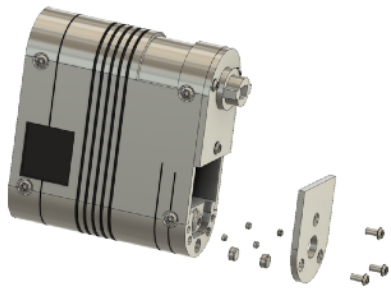

DO NOT SCREW the "Front Plate Bottom" to the "Main Body" use 2 x 6mm x 3mm Magnets and 4 x 3mm x 2mm Magnets to hold in place. The 3 x M3 Screws are for decorative purposes ONLY

Hardware:

- 2 x 6mm x 3mm Magnets
- 4 x 3mm x 2mm Magnets
- 3 x M3 x 6mm Button Head Screws



Completed "Main Body"

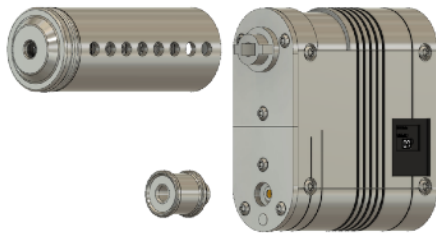

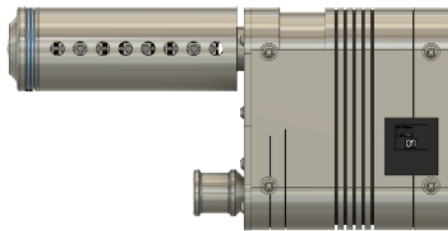

Push Fit both the "Main Barrel" and "Small Barrel" on to the front of the "Main Body"

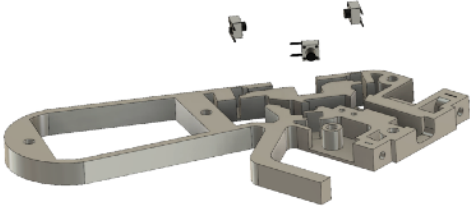
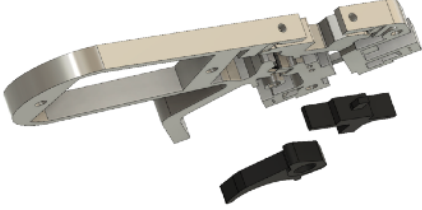
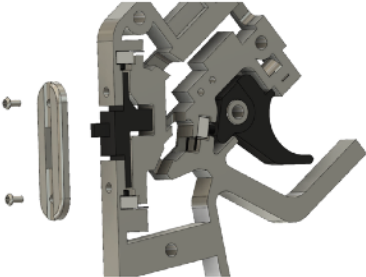
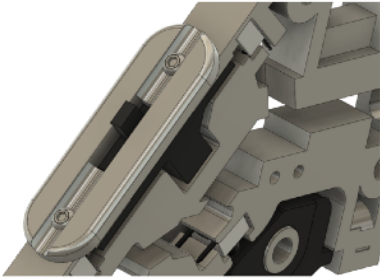
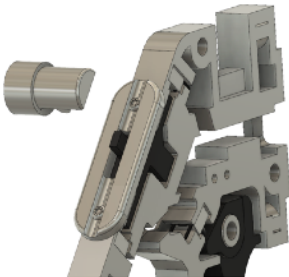
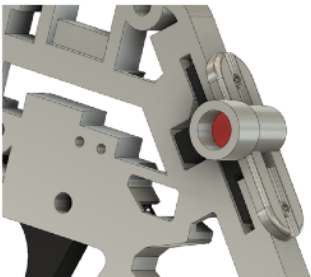

2nd Stage Complete

7.3. Grip and Trigger

	<p>Place the 3 x 6mm Tactile Switches inside the “Grip Frame” The longer button switch is the Trigger switch</p> <p>Electronics: 2 x Tactile Switches - 6 x 6 x 4mm 1 x Tactile Switch - 6 x 6 x 7mm</p>
	<p>Slide the “Trigger” on to the trigger pin and slot the “Slider Mechanism” into the slot between the 2 tactile switches (Will only fit one way round)</p>
	<p>Screw the “Slider Base Plate” on to the “Grip Frame” with 2 x M2 x 4mm Button Head Screws</p> <p>Hardware: 2 x M2 x 4mm Button Head Screws</p>
	<p>Check that the “Slider Mechanism” moves freely and activates both switches</p>
	<p>Glue the “Slider Button” onto the “Slider Mechanism”</p>
	<p>Check the “Slider Button” moves and activates both switches</p>
	<p>Position the “Grip Plate (LEFT)” and “Grip Plate (RIGHT)” onto the “Grip Frame” aligning the holes</p>

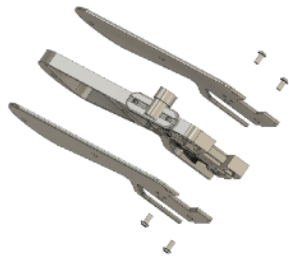

Secure with 4 x M3 x 6mm Button Head Screws (2 on each side)

Hardware:

4 x M3 x 6mm Button Head Screws

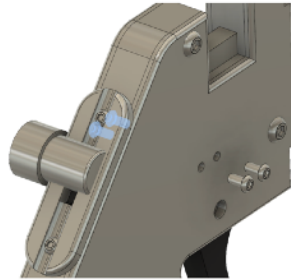

Screw 4 x M2 x 6mm Button Head Screws - 2 on each "Grip Plate" to the "Grip Frame" These are for decorative purposes only

Hardware:

4 x M2 x 6mm Button Head Screws



Position both "Grip Handle (LEFT) and "Grip Handle (RIGHT" onto the "Grip Frame" aligning the holes



Secure with 4 x M3 x 6mm Button Head Screws (2 on each side)

Hardware:

4 x M3 x 6mm Button Head Screws



Slot the "Back Plate" onto the "Grip Frame" making sure you have the correct way around and secure with 2 x M3 x 6mm Button Head Screws

Hardware:

2 x M3 x 6mm Button Head Screws



3rd Stage Complete

7.4. Chassis

	<p>Fir the Mini Slide Switch into the hole on the front inner side front of the “Chassis Main Body”</p> <p>Electronics: Mini Slide Switch</p>
	<p>Use Hot Glue to hold the TP4056 Charger in place in the small tray on the side of the “Chassis Main Body”</p> <p>Electronics: TP4056 Battery Charger</p>
	<p>Place a 6mm Tactile Switch in the slot on the back of the “Chassis Main Body”</p> <p>Hardware: 1 x Tactile Switch - 6 x 6 x 7mm</p>
	<p>The PropTroniX completed electronics PCB slides into the “Cassis Main Body from the bottom</p>
	<p>The “Chassis Cover” is designed to Snap Fit onto the “Chassis Main Body” so no need to glue</p>
	<p>4th Stage Complete</p>
	<p>To fit the “Chassis” into the NN-14 Blaster you will need to remove the “Main Body Panel (LEFT)”, “Main Body Bottom” and “Front Plate Bottom”</p>

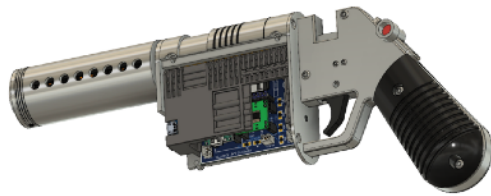

Connect all the JST Leads to the PCB before sliding in carefully to make sure you don't snag any of the wires. Then refit the "Main Body Panel (LEFT)", "Main Body Bottom" and "Front Plate Bottom"

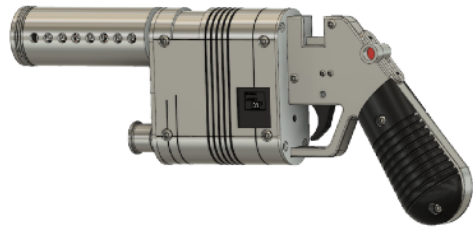

You now have a completed NN-14 Blaster with Lights and Sounds

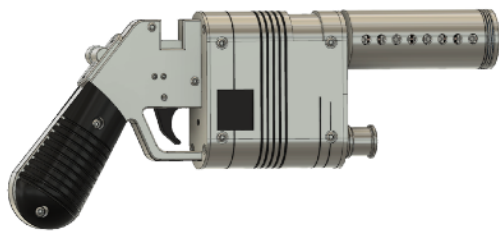

Trigger - Fire
Slide Switch - UP - Weapon Reload
Slide Switch - DOWN - Weapon Select
Small Button - Laser On/Off

2.5. Stand



Glue the "Long Stand Upright" and "Small Stand Upright" to the "Stand Base"



"Long Stand Upright" on the Left of "Stand Base" - View Left Side of Blaster
"Long Stand Upright" on the Right of "Stand Base" - View Right Side of Blaster

8. Completed Images

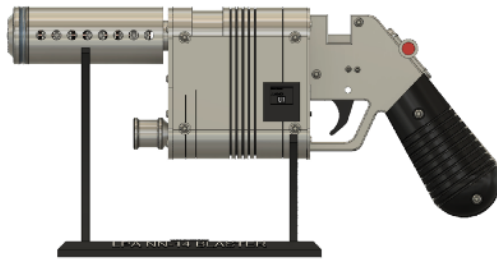

NN-14 Left Side View

[View Larger Image](#)

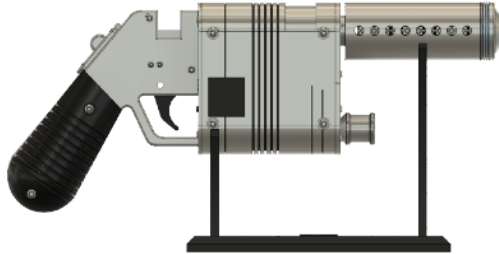

NN-14 Right Side View

[View Larger Image](#)

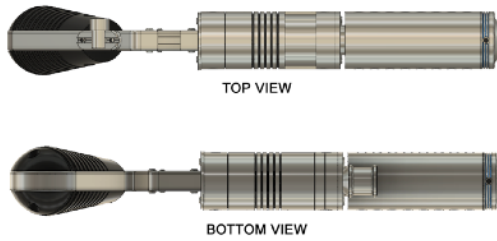

NN-14 Top and Bottom Views

[View Larger Image](#)

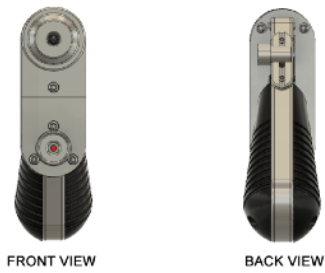

NN-14 Front and Back Views

[View Larger Image](#)

NN-14 Blaster - BLTroniX Electronics Kit Demo

Rey's NN-14 Blaster



3D Printed
Fitted with



Galactic Props 
Star Wars Props and Electronics

PropTroniX 
Star Wars Props and Electronics

10. Links to the Additional Kits

To purchase any of the Kits just Click the Link to the Right.

<p>NN-14 Blaster BLTroniX Electronics Kit Available as a Self Build or Pre Built Kit.</p>	<p>COMING SOON</p>
<p>NN-14 Blaster Pistol Hardware Kit Contains all the Screws and Springs Needed for your NN-14 Stormtrooper Blaster Pistol Build.</p>	<p>NN-14 Hardware Kit</p>

Other Electronics Kits and Components are available for your Prop Builds so why not Visit the [PropTroniX Store](#).